

13 x 17 double deck rental kit to include:

- (1) 13'1" x 16'11" second level with extended landing and straight staircase
- (1) 184" wide backwall with storage closet under stairs
- (1) "EV2" locking standalone counter, 46"w x 20"d black laminate top
- (1) large format lightbox wall on front of deck
- (2) rail mount lightboxes
- (1) adjustable divider wall upstairs
- (1) gray sintra ceiling with 16 track lights
- (1) 1/4" thick frosted plex rail infills

CHOICE of black, white, or gray sintra provided standard for all solid infill walls that do not have graphics, unless described otherwise

\*White laminate standard for EV2 wall counter sides and standalone counter front and sides

Consult your account rep for options. Additional elements, merchandising and graphics are available

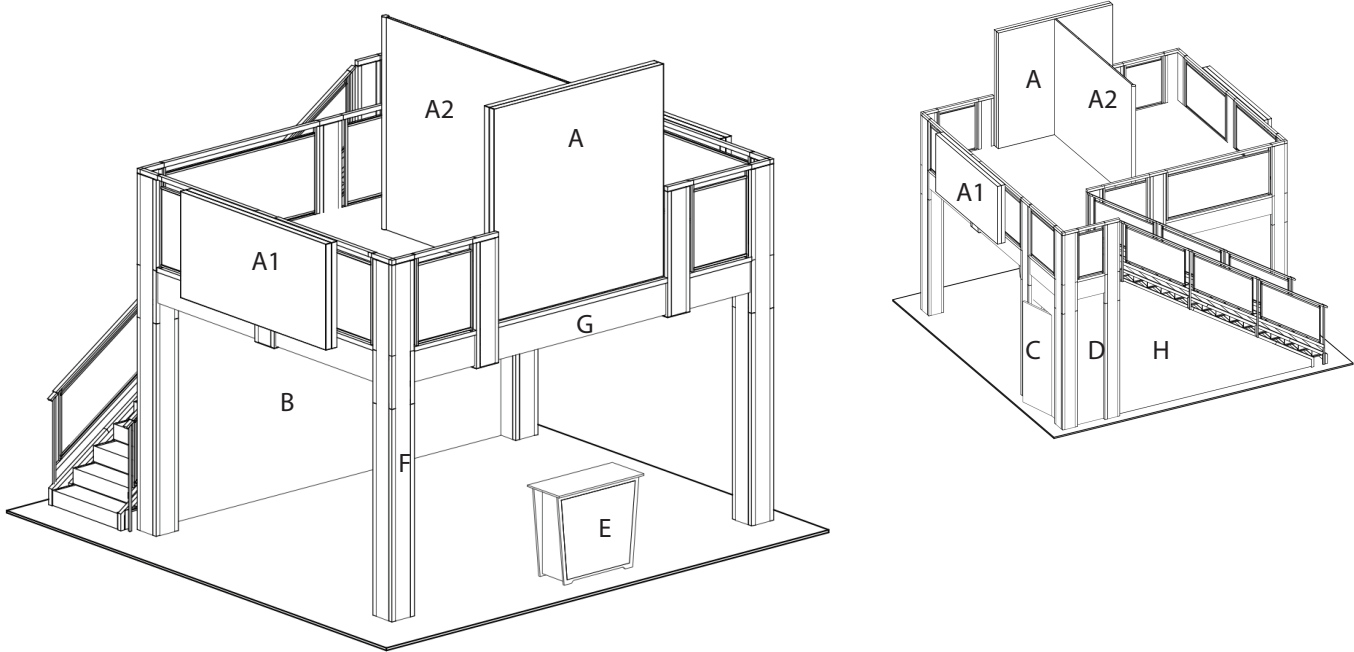

GRAPHIC SPECS

- A. - (2) 92"w x 92" h Backlit Fabric Graphic
- A1. - (2) 92"w x 46" h Backlit Fabric Graphic
- A2. - (2) 115"w x 92" h Sintra Graphic
- B. - (1) 183.5"w x 99" h Sintra Graphic (Back Wall)
- C. - (1) 38.5" w x 99" h Sintra Graphic (with door)
- D. - (1) 22.5" w x 99" h Sintra Graphic
- E. - (1) 40" w x 35" h Counter Graphic
- F. - (46 pieces total) 7-7/8" wide x various height column infill (4 sides per column plus upstairs inside) 1 example piece notated
- G. - (11 pieces total) various widths x 14" high beam covers) 1 example piece notated
- H. - angle wall beneath stairs

**KIT PACKAGE PRICING DOES NOT INCLUDE chairs, benches, tables, computers, monitors/cables, and carpet. Additional elements, merchandising and graphics are available through your account representative.**

**Please follow our graphic file submission guidelines for all printed elements to avoid resubmission requests and delay. Allow at least 10 business days for graphic production.**

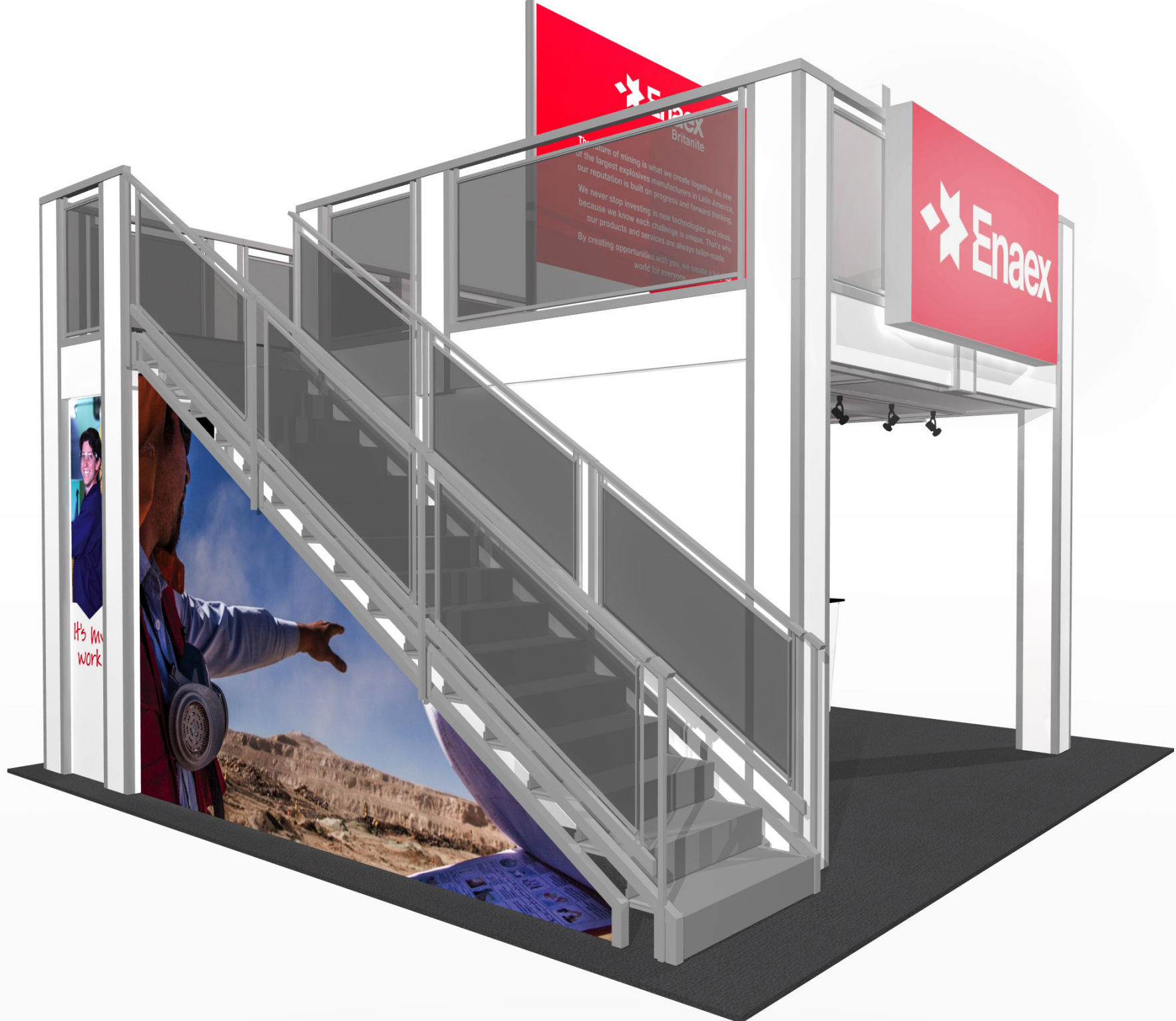

Enaex

Enaex

Enaex  
A high level of safety and  
efficiency. In line with the  
company's commitment to  
sustainability and  
innovation.  
We are a team of professionals  
dedicated to providing  
the best solutions for our  
clients.







A brighter definition of success is already within reach. We know about making mines more productive through custom blasting solutions and long-term partnerships, but our vision doesn't end there.

We strive to create healthier lifestyles for people in the industry, minimizing risk and uplifting families.

These commitments and aspirations have made us a world leader in low-density ammonium nitrate production and fully integrated rock fragmentation services.

It's m... sibility





Enaex  
Britanite

the future of mining  
the largest  
solution is  
Never stop  
cause we know  
our products  
creating opp

Evolu

In Latin America  
forward thinking,  
ologies and ideas,  
nique. That's why  
s tailor-made.  
create a brighter

anges

Enaex

Enaex

A brighter definition of success is already within reach. We know about making mines more productive through custom blasting solutions and long-term partnerships, but our vision doesn't end there. We strive to create healthier lifestyles for people in the industry, minimizing risk and uplifting families. These commitments and aspirations have made us a world leader in low-density ammonium nitrate production and fully integrated rock fragmentation services.

It's my responsibility

Enaex  
Britanite

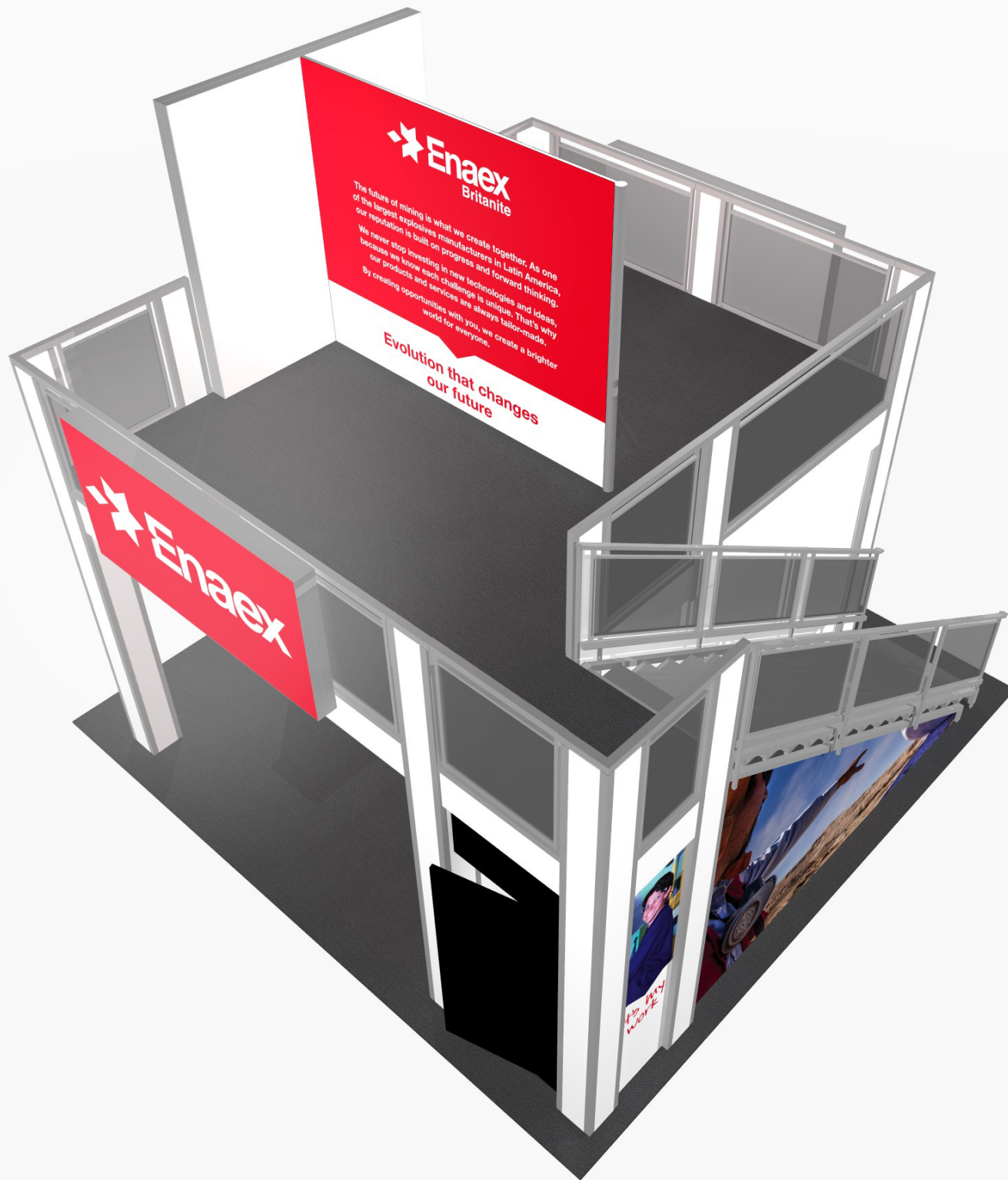

 **Enaex**  
Britanite

The future of mining is what we create together. As one of the largest explosives manufacturers in Latin America, our reputation is built on progress and forward thinking. We never stop investing in new technologies and ideas, because we know each challenge is unique. That's why our products and services are always tailored-made. By creating opportunities with you, we create a brighter world for everyone.

**Evolution that changes  
our future**

 **Enaex**

  
The Best  
Work





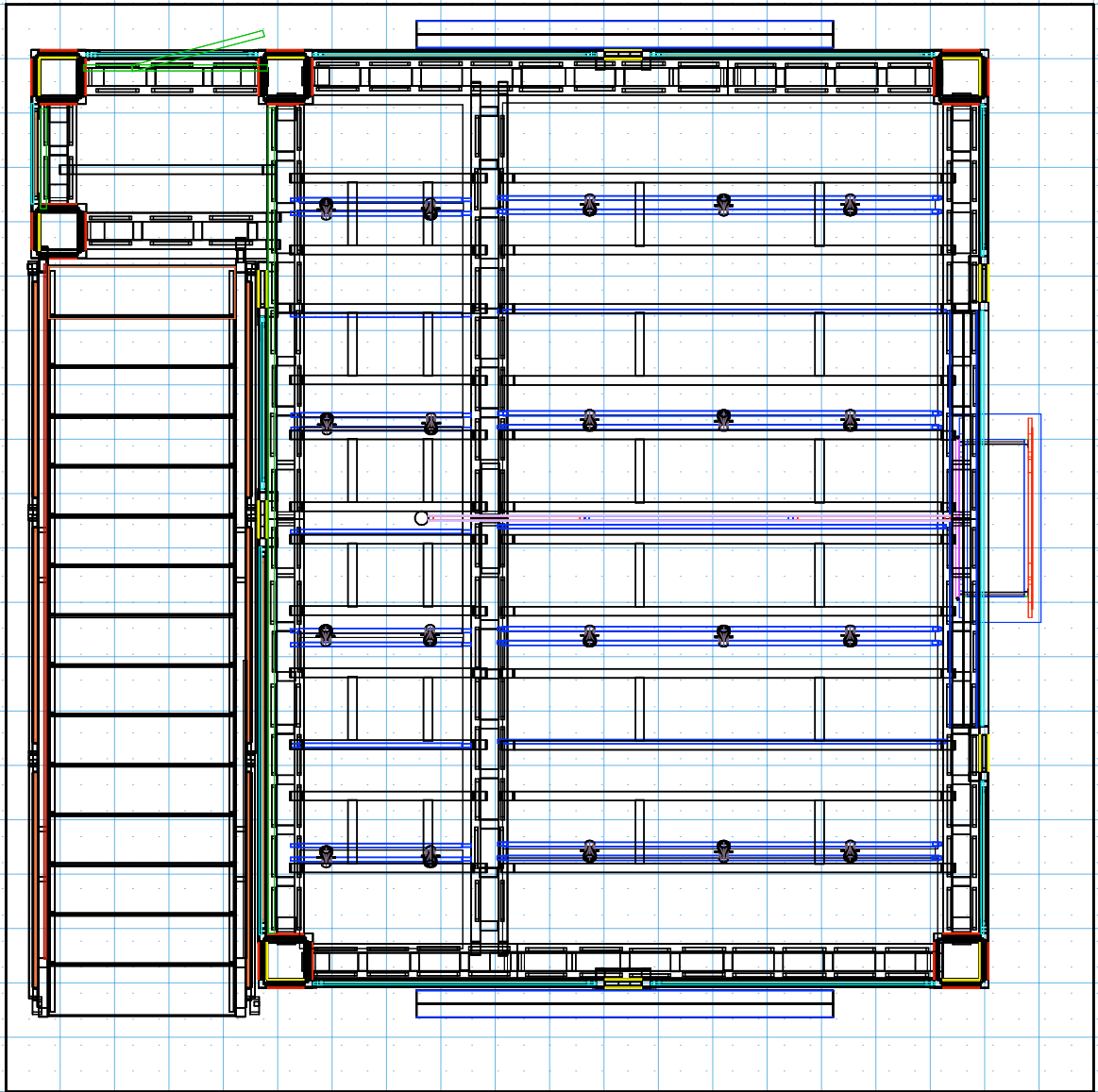

DRAWN BY: LH

**DESIGN : DD1317-LSS-RG**

**DATE:** 04/21/2020

**REFERENCE:** 20X20

© 2020

The designs shown herein are protected by copyright and other laws. This document is to be maintained in confidence. No portion of the information or design shown herein may be reproduced, electronically or otherwise, nor may any display be made from this design without written consent.

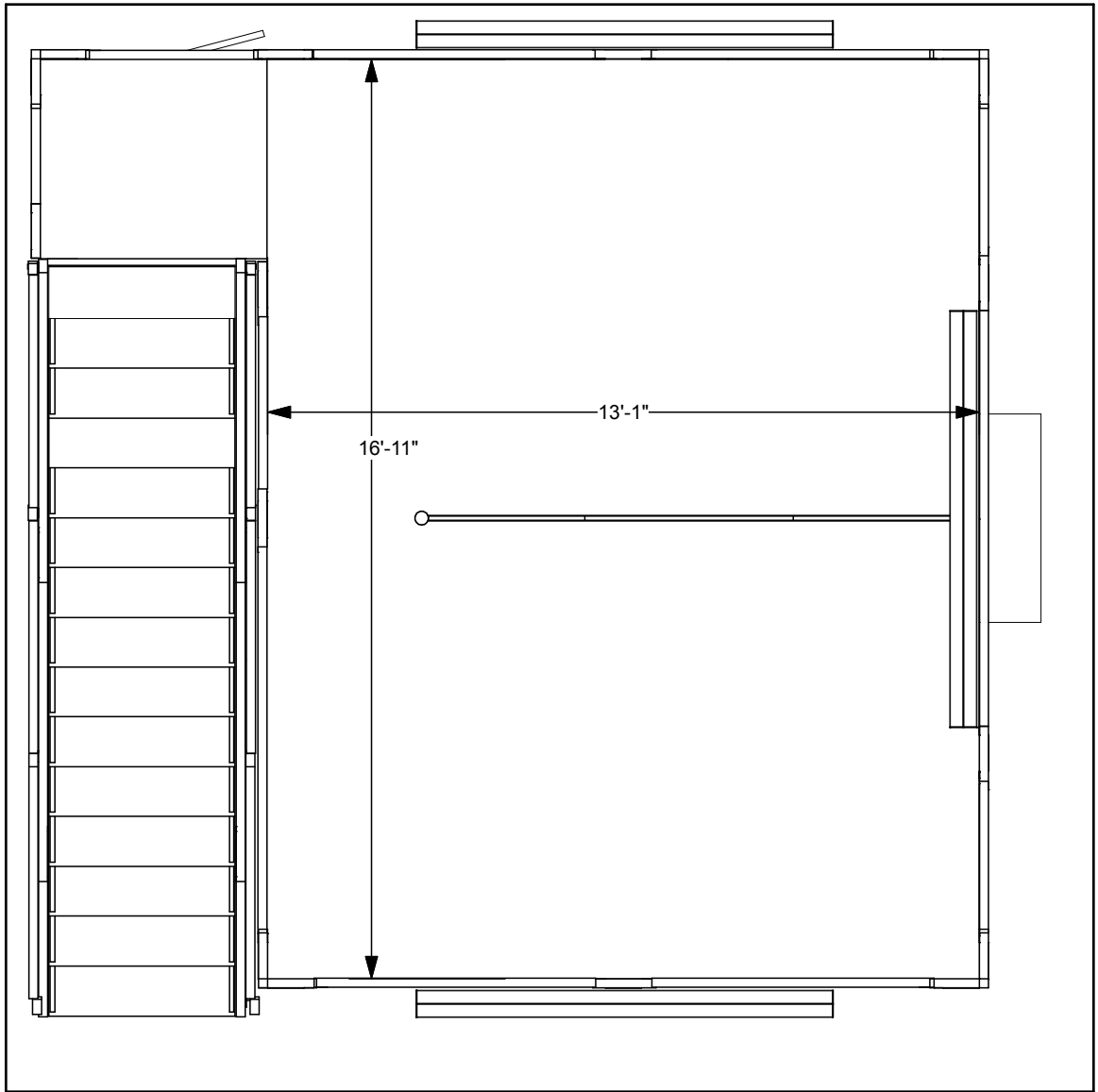

DRAWN BY: LH



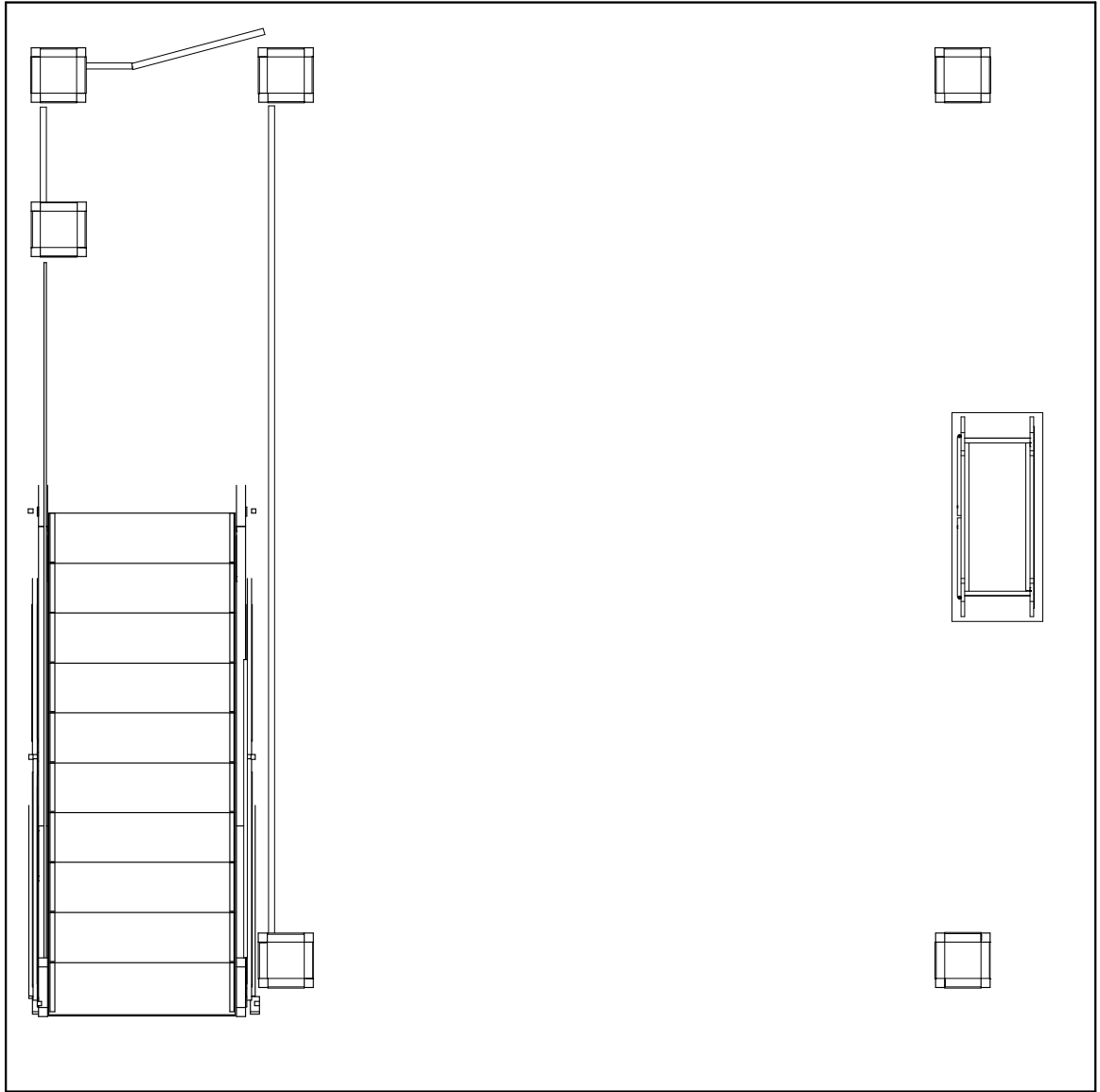

DRAWN BY: LH

**DESIGN : DD1317-LSS-RG**

**DATE:** 04/21/2020

**REFERENCE:** 20X20

© 2020

The designs shown herein are protected by copyright and other laws. This document is to be maintained in confidence. No portion of the information or design shown herein may be reproduced, electronically or otherwise, nor may any display be made from this design without written consent.

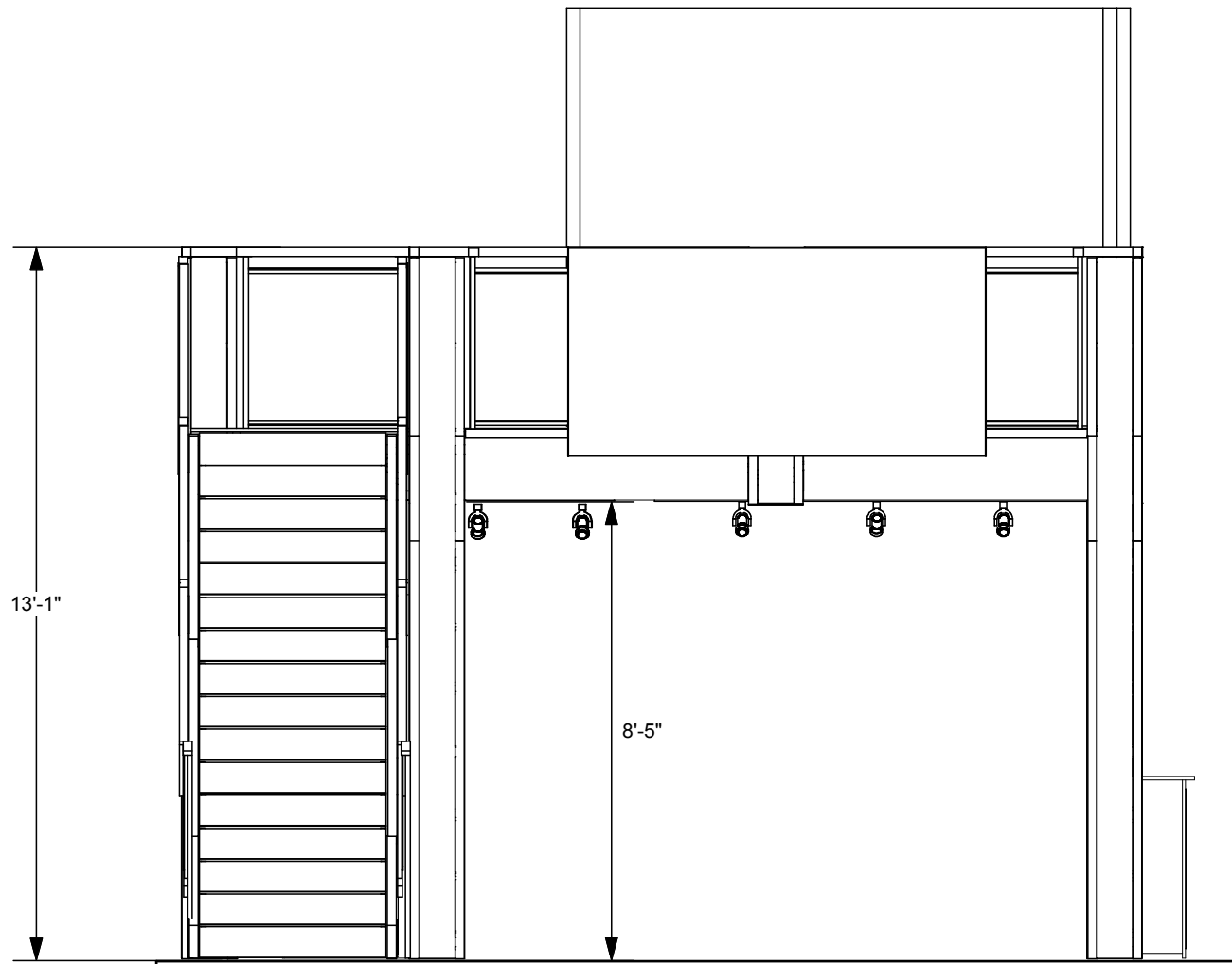

DRAWN BY: LH

**DESIGN : DD1317-LSS-RG**

**DATE: 04/21/2020**

**REFERENCE: 20X20**

**© 2020**

The designs shown herein are protected by copyright and other laws. This document is to be maintained in confidence. No portion of the information or design shown herein may be reproduced, electronically or otherwise, nor may any display be made from this design without written consent.

TEMPLATE AT 5% FINAL SIZE OF 157.75"w x104.94"h

File submission: Final raster images should be minimum of 75-100 DPI original resource AT PRINT SIZE. Add .5" bleed all around in addition to template dimensions.

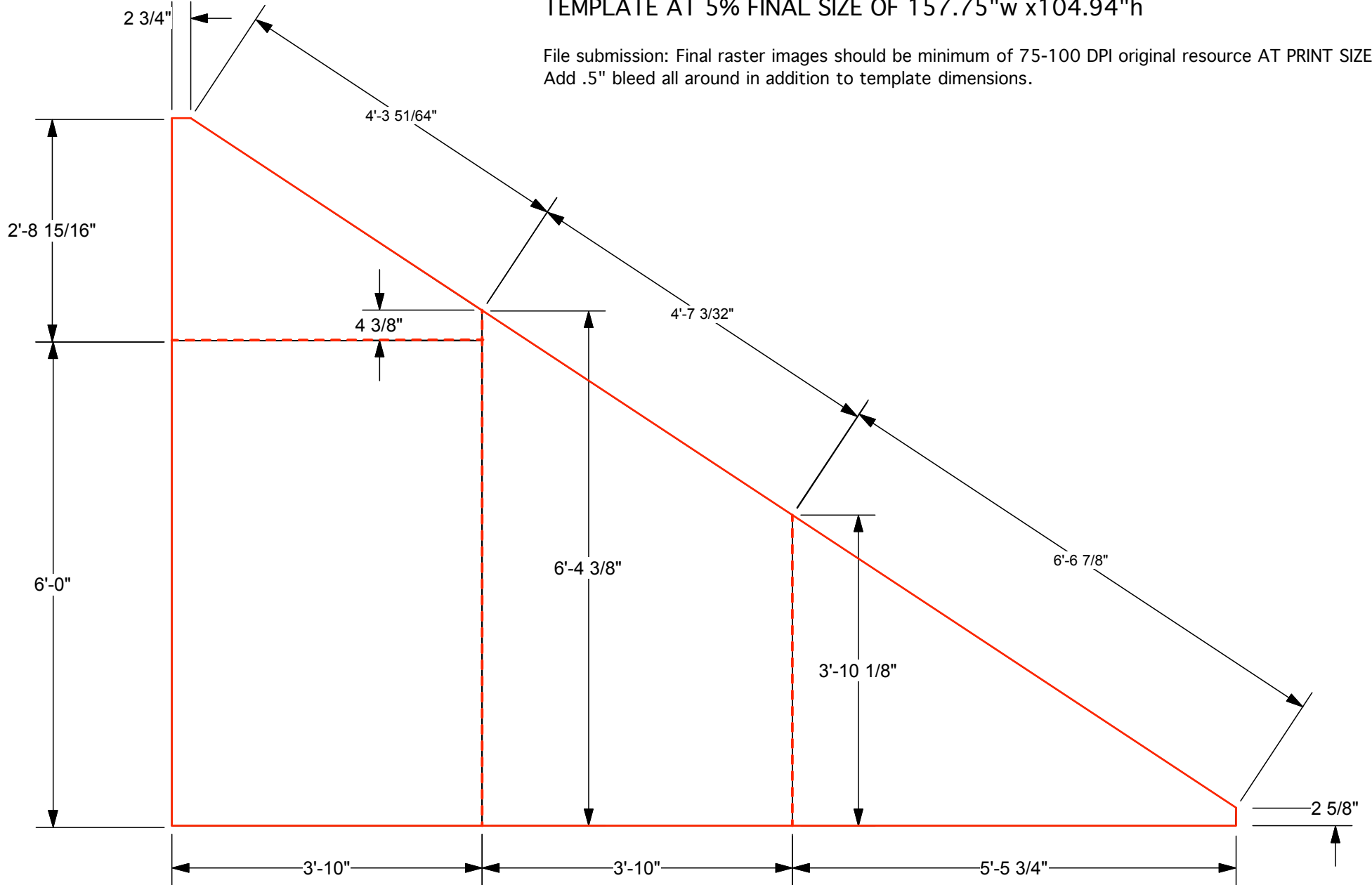

DRAWN BY: NG

DESIGN : STAIR ANGLE WALL - TEMPLATE REVERSE

DATE: 5/28/17

REFERENCE: DECK

© Trussworks 2017

The designs shown herein are the proprietary property of Trussworks and protected by copyright and other laws. This document is to be maintained in confidence. No portion of the information or design shown herein may be reproduced, electronically or otherwise, nor may any display be made from this design without written consent from Trussworks.

# EV2 STANDALONE COUNTER - STANDARD FRONT GRAPHIC SPECIFICATIONS

Graphic will be created as a low-tac adhesive fabric decal, **for one time use application.** Graphics must be reprinted for additional events.

Template shows maximum live graphic size of 40"w (at top) x 35"h. Profile cut art may be smaller, and will be centered on counter front. Vector cut lines must be provided in supplied art files for profile cut decals. White laminate counter front will be visible around decal.

Please provide .5" bleed at all edges in art files.

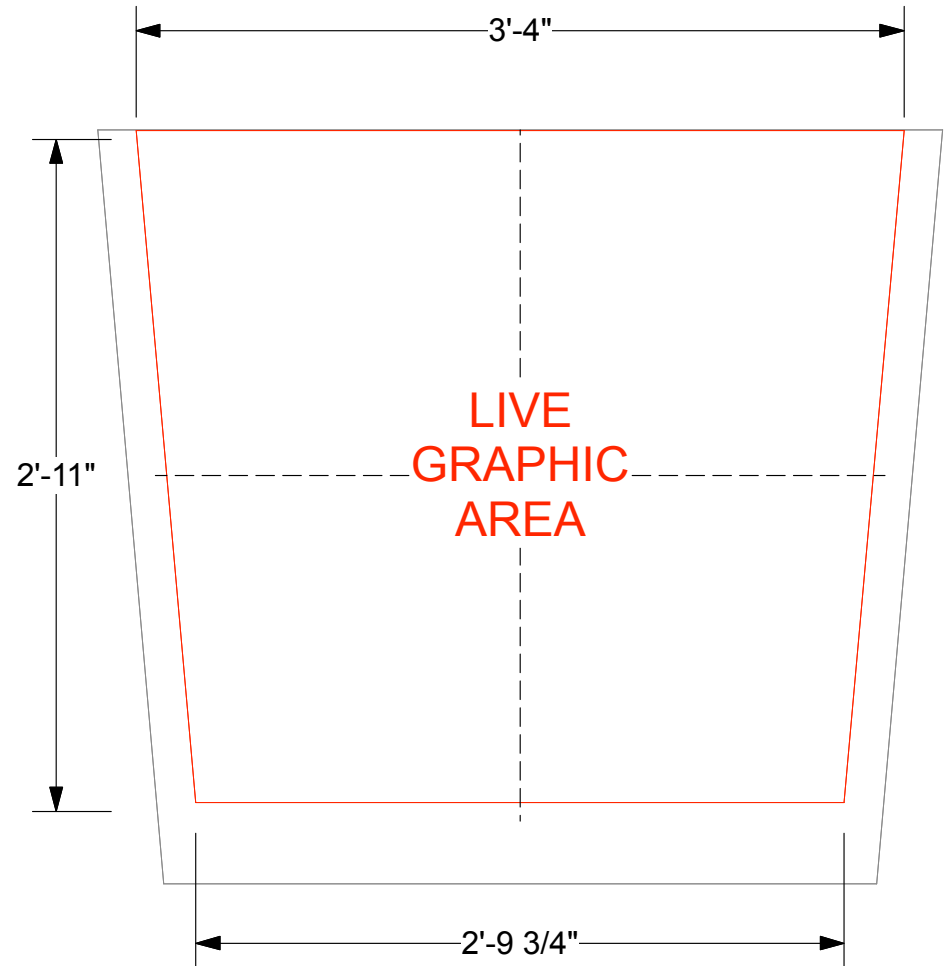

- COUNTER, 44"w x 39.25"h total dimension of front
- MAXIMUM LIVE GRAPHIC AREA, 40"w x 35"h



DRAWN BY: NG

DESIGN : EV2 Graphic Production Materials

DATE: 8/28/17

REFERENCE: EV2 - STNDLN © Trussworks 2017

The designs shown herein are the proprietary property of Trussworks and protected by copyright and other laws. This document is to be maintained in confidence. No portion of the information or design shown herein may be reproduced, electronically or otherwise, nor may any display be made from this design without written consent from Trussworks.