

9 x 17 double deck rental kit to include:

- (1) 9'3" x 16'11" second level with landing and straight staircase
- (1) 184" wide backwall with extended storage closet under stairs and landing
- (1) "EV2" locking standalone counter, 46"w x 20"d black laminate top
- (1) gray sintra ceiling with 12 track lights
- (1) 1/4" thick frosted plex rail infills

CHOICE of black, white, or gray sintra provided standard for all solid infill walls that do not have graphics, unless described otherwise

*White laminate standard for EV2 wall counter sides and standalone counter front and sides

Consult your account rep for options. Additional elements, merchandising and graphics are available

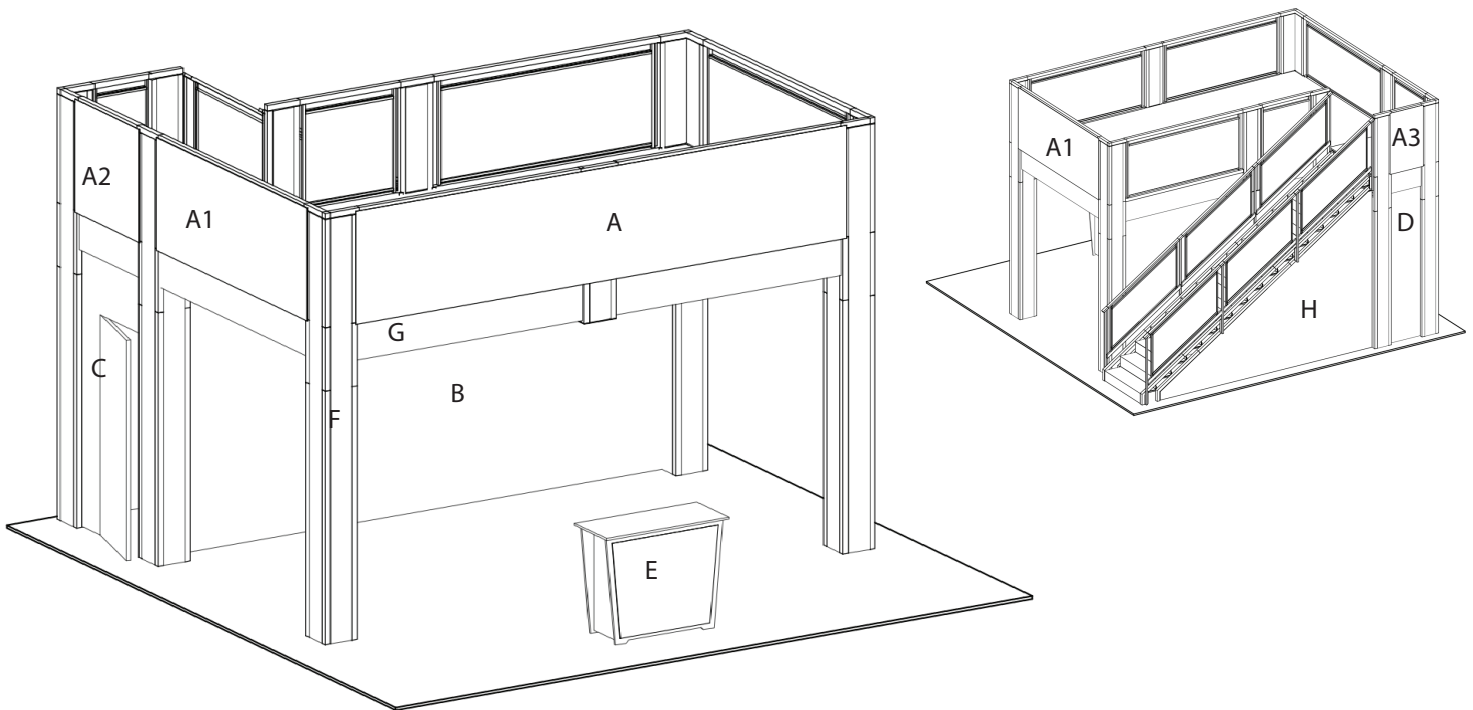

GRAPHIC SPECS

- A. - (1) 185" w x 41" h rollable lamda graphic
- A1. - (2) 93" w x 41" h rollable lamda graphic
- A2. - (1) 40" w x 41" h rollable lamda graphic
- A3. - (1) 24" w x 41" h rollable lamda graphic
- B. - (1) 183.5" w x 99" h Sintra Graphic (Back Wall)
- C. - (1) 38.5" w x 99" h Sintra Graphic (Panel with door)
- D. - (1) 22.5" w x 99" h Sintra Graphic (back panel of closet)
- E. - (1) 40" w x 35" h Counter Graphic
- F. - (40 pieces total) 7-7/8" wide x various height column infill (4 sides per column plus upstairs inside) 1 example piece notated
- G. - (8 pieces total) various widths x 14" high beam covers) 1 example piece notated
- H. - angle wall beneath stairs

KIT PACKAGE PRICING DOES NOT INCLUDE chairs, benches, tables, computers, monitors/cables, and carpet. Additional elements, merchandising and graphics are available through your account representative.

Please follow our graphic file submission guidelines for all printed elements to avoid resubmission requests and delay. Allow at least 10 business days for graphic production.



NORTON
SAINT-GOBAIN

END THE DAY
YOUR WAY

NORTON
SAINT-GOBAIN

END THE DAY
YOUR WAY



NORTON

SAINT-GOBAIN

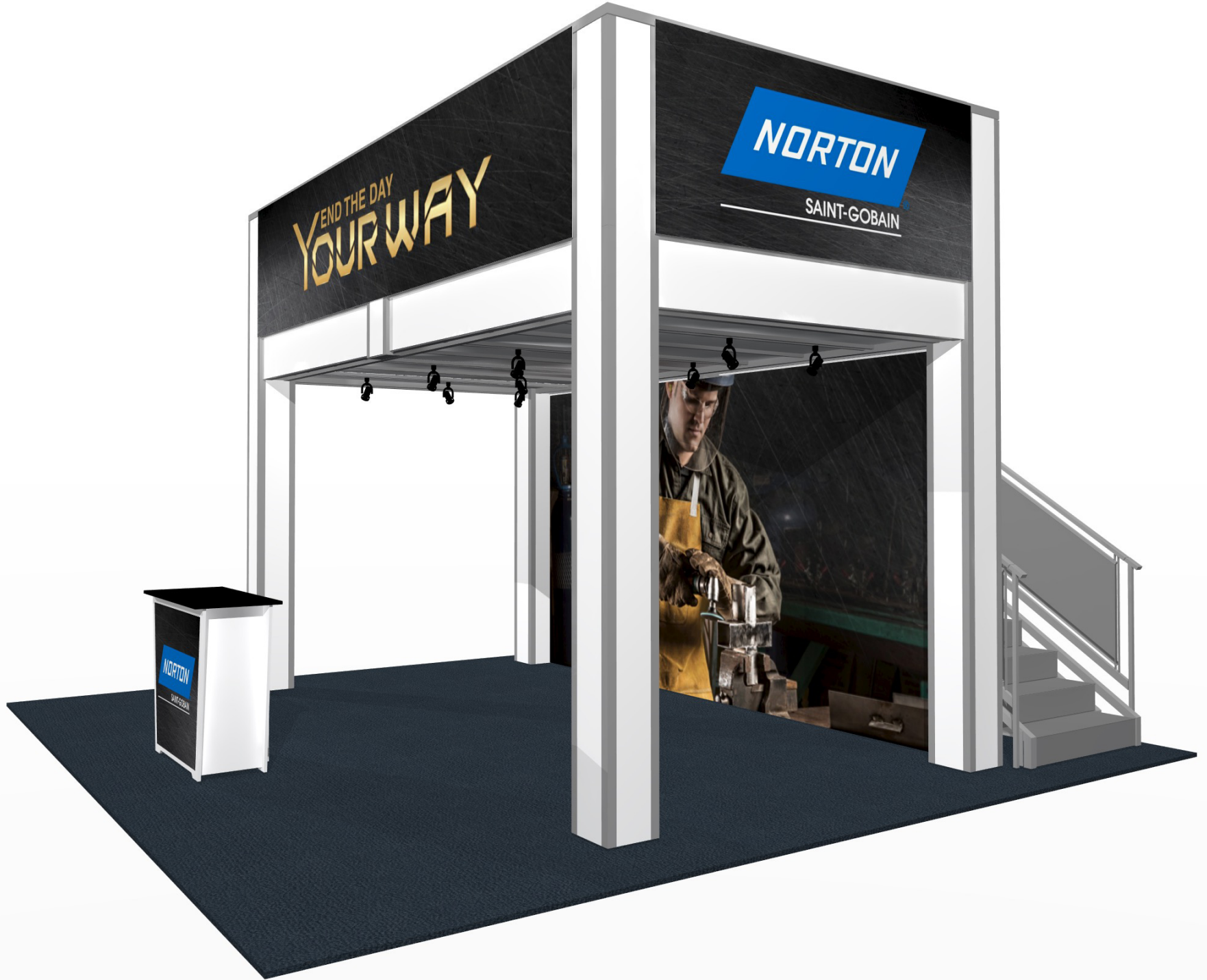

END THE DAY
YOUR WAY

NORTON
SAINT-GOBAIN

NORTON
SAINT-GOBAIN

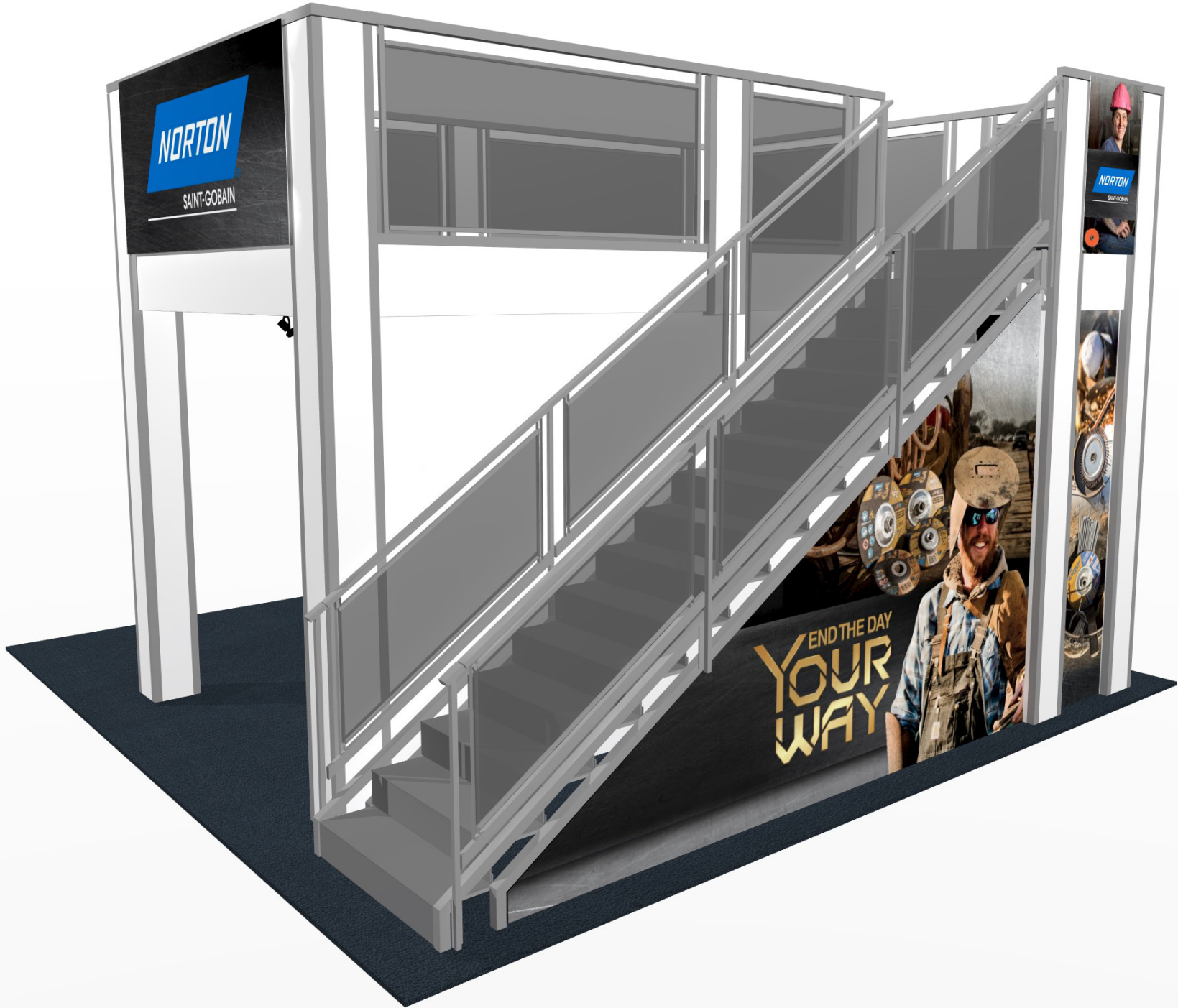

NORTON

SAINT-GOBAIN

NORTON

SAINT-GOBAIN

END THE DAY
YOUR WAY

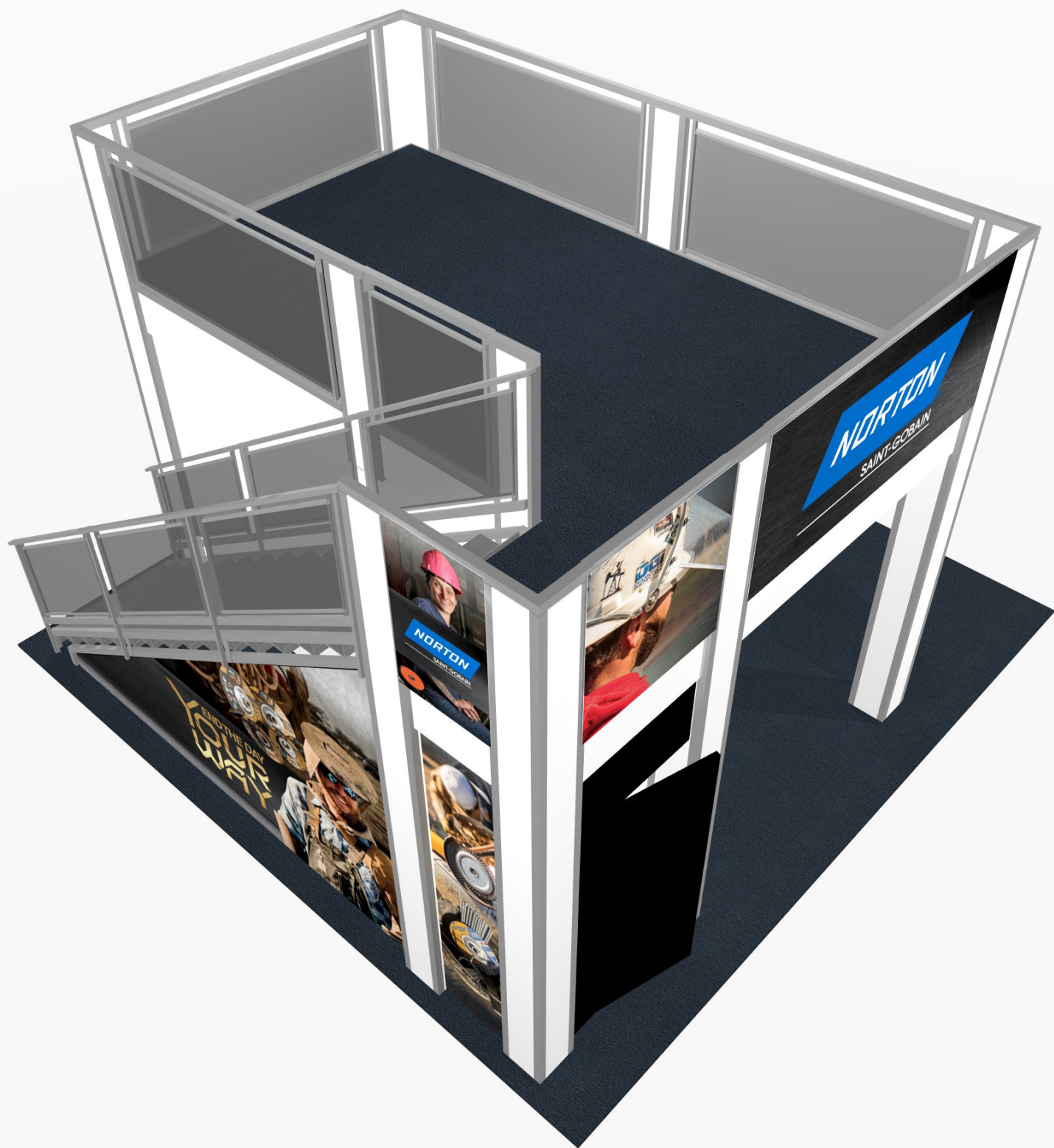

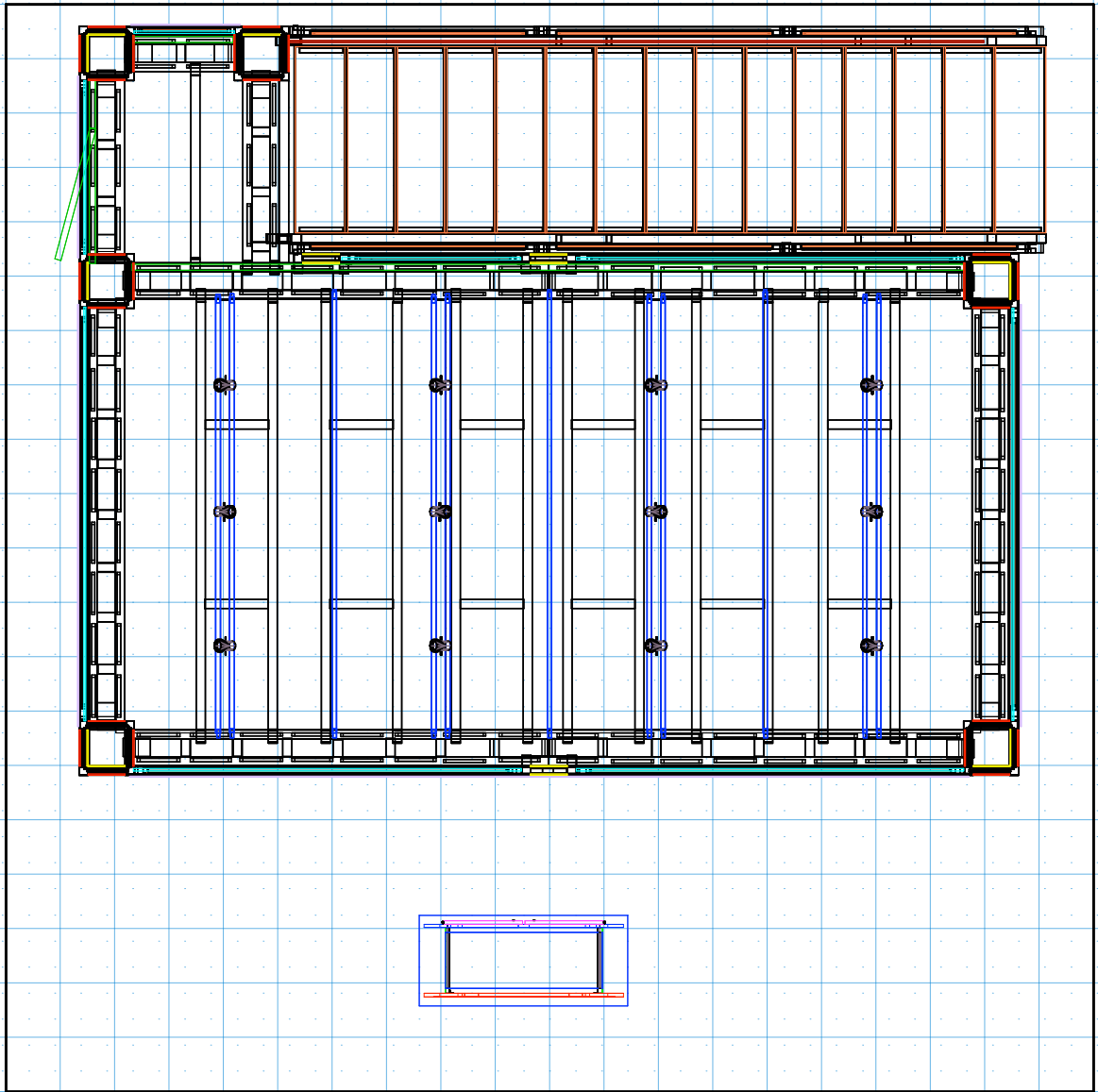

DRAWN BY: LH

DESIGN : DD913-LSS-RG

DATE: 04/21/2020

REFERENCE: 20X20

© 2020

The designs shown herein are protected by copyright and other laws. This document is to be maintained in confidence. No portion of the information or design shown herein may be reproduced, electronically or otherwise, nor may any display be made from this design without written consent.

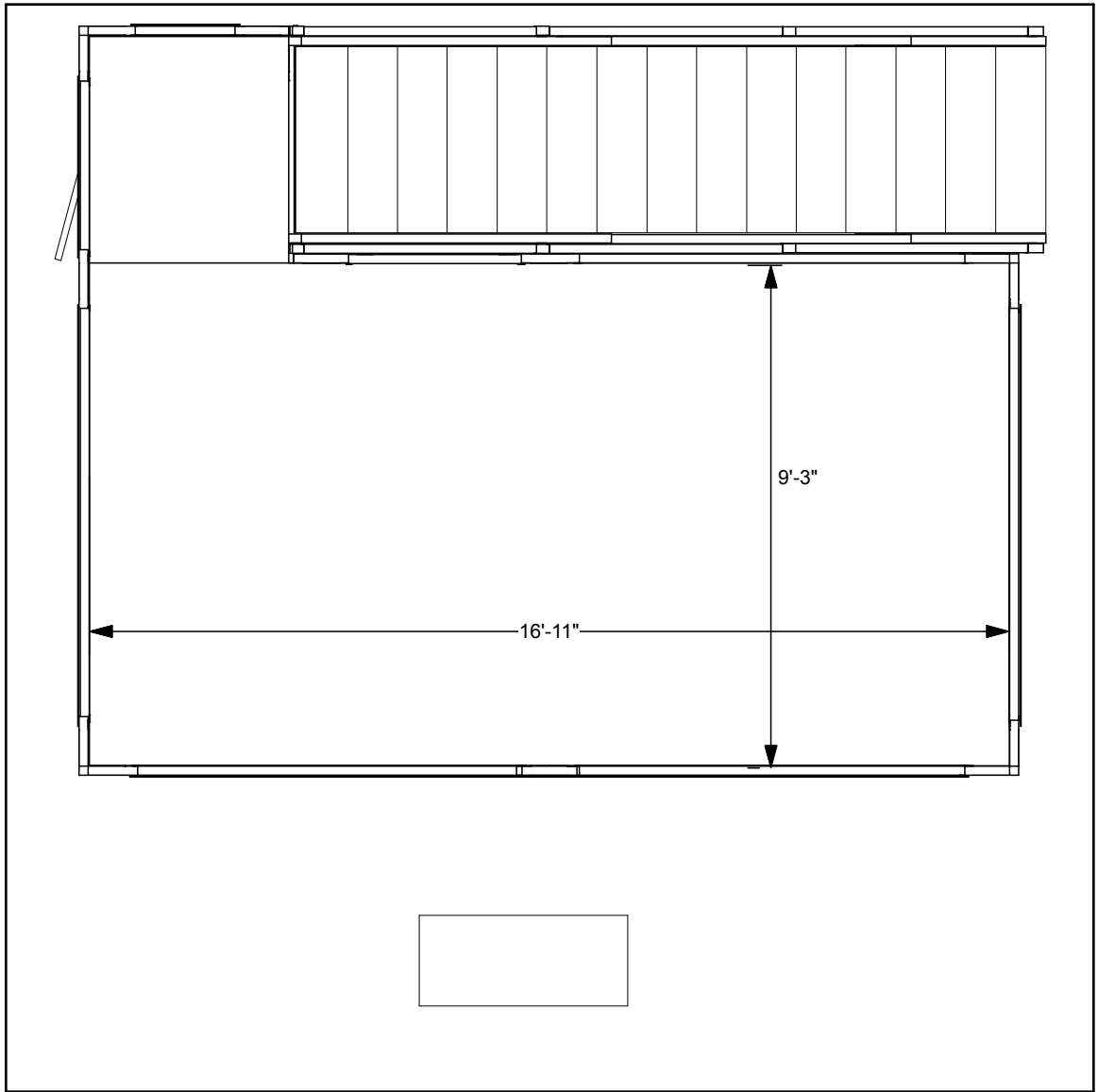

DRAWN BY: LH

DESIGN : DD913-LSS-RG

DATE: 04/21/2020

REFERENCE: 20X20

© 2020

The designs shown herein are protected by copyright and other laws. This document is to be maintained in confidence. No portion of the information or design shown herein may be reproduced, electronically or otherwise, nor may any display be made from this design without written consent.

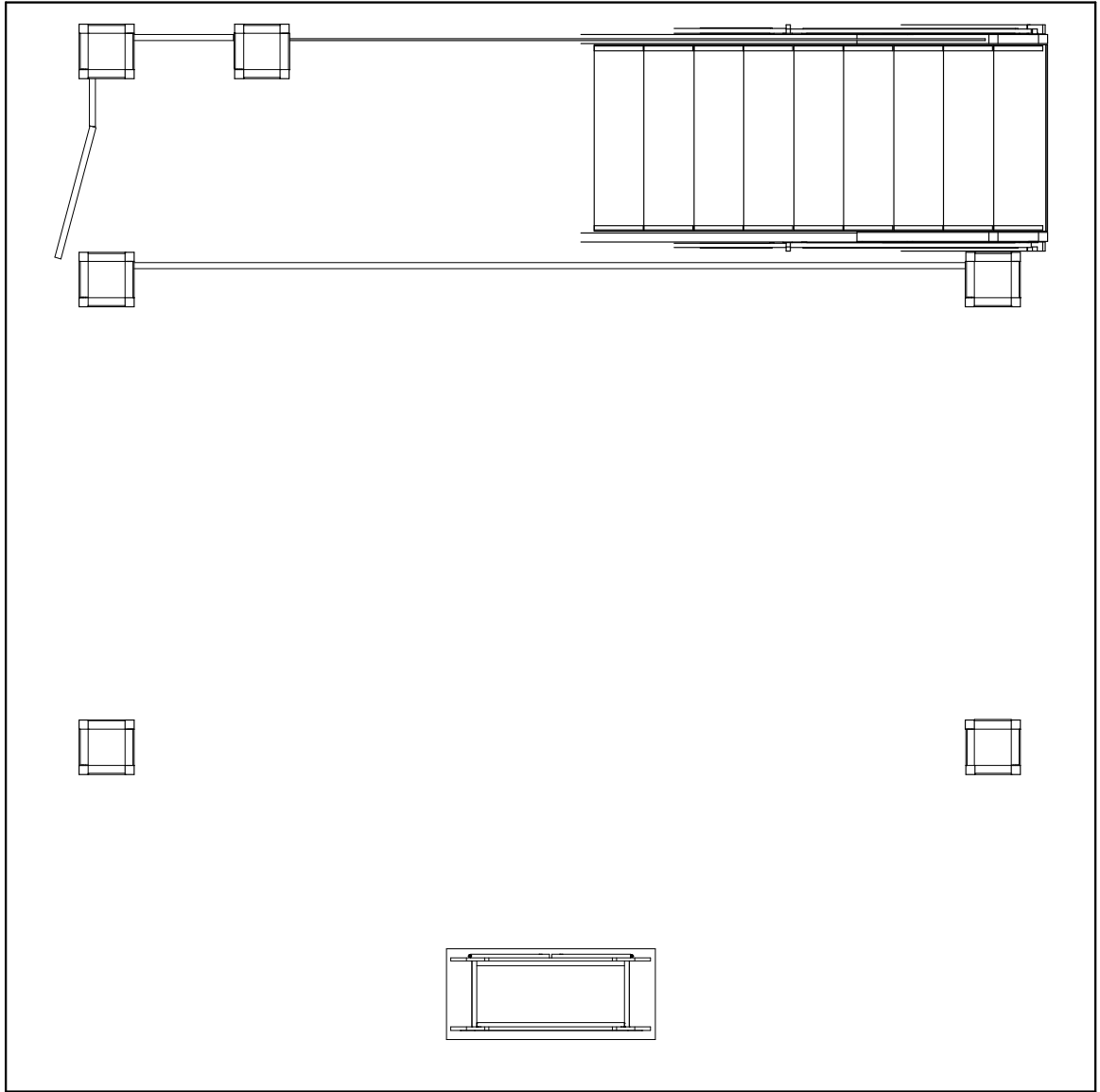

DRAWN BY: LH

DESIGN : DD913-LSS-RG

DATE: 04/21/2020

REFERENCE: 20X20

© 2020

The designs shown herein are protected by copyright and other laws. This document is to be maintained in confidence. No portion of the information or design shown herein may be reproduced, electronically or otherwise, nor may any display be made from this design without written consent.

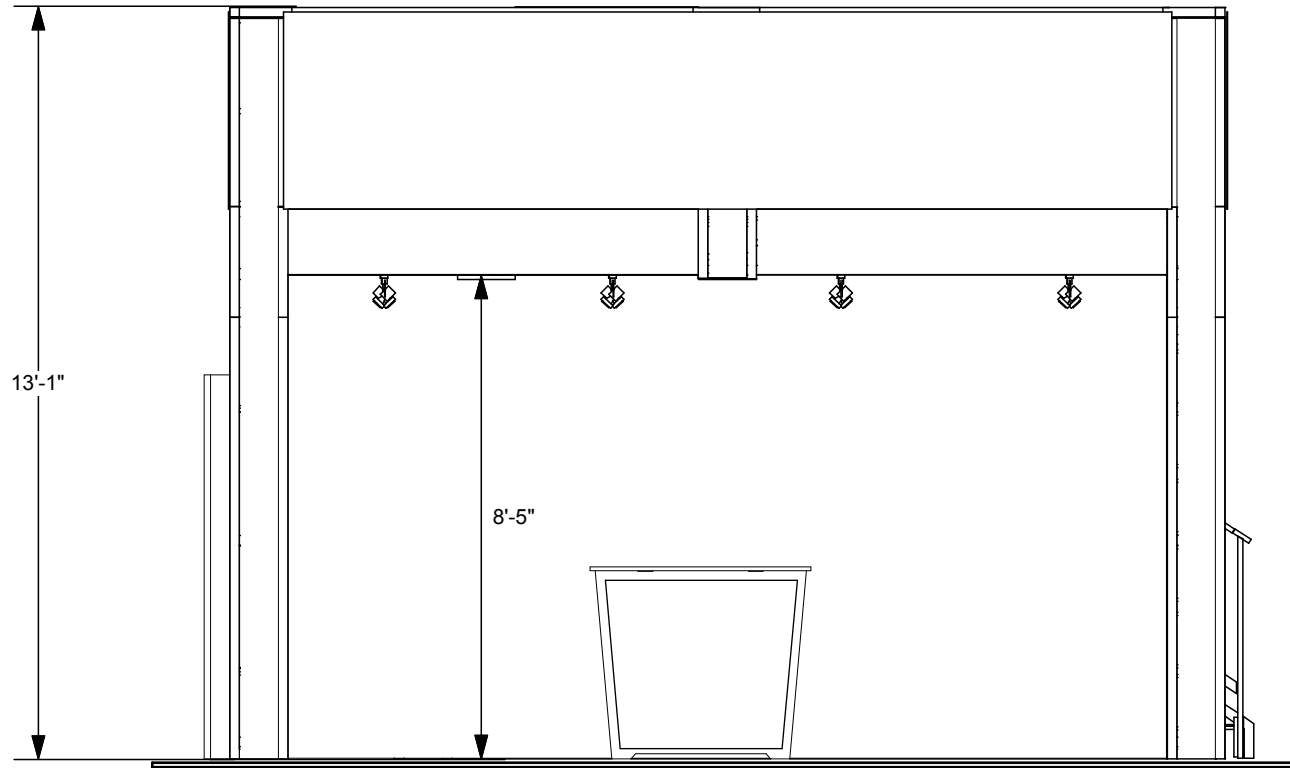

DRAWN BY: LH

DESIGN : DD913-LSS-RG

DATE: 04/21/2020

REFERENCE: 20X20

© 2020

The designs shown herein are protected by copyright and other laws. This document is to be maintained in confidence. No portion of the information or design shown herein may be reproduced, electronically or otherwise, nor may any display be made from this design without written consent.

TEMPLATE AT 5% FINAL SIZE OF 157.75"w x104.94"h

File submission: Final raster images should be minimum of 75-100 DPI original resource AT PRINT SIZE.
Add .5" bleed all around in addition to template dimensions.

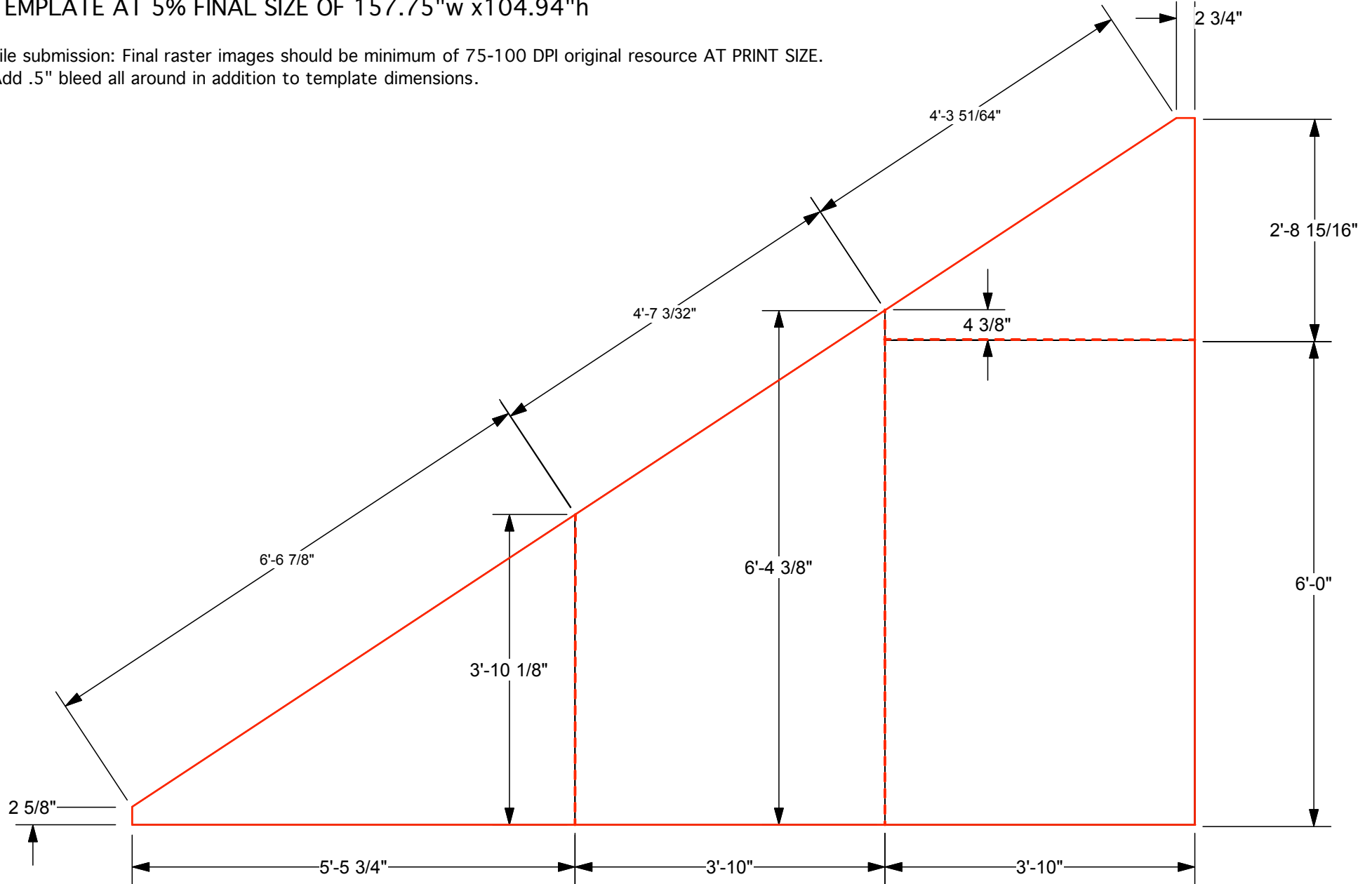

DESIGN : STAIR ANGLE WALL - TEMPLATE

DATE: 5/28/17

REFERENCE: DECK

DRAWN BY: NG

© Trussworks 2017

The designs shown herein are the proprietary property of Trussworks and protected by copyright and other laws. This document is to be maintained in confidence. No portion of the information or design shown herein may be reproduced, electronically or otherwise, nor may any display be made from this design without written consent from Trussworks.

EV2 STANDALONE COUNTER - STANDARD FRONT GRAPHIC SPECIFICATIONS

Graphic will be created as a low-tac adhesive fabric decal, **for one time use application.**
 Graphics must be reprinted for additional events.

Template shows maximum live graphic size of 40"w (at top) x 35"h.
 Profile cut art may be smaller, and will be centered on counter front.
 Vector cut lines must be provided in supplied art files for profile cut decals.
 White laminate counter front will be visible around decal.

Please provide .5" bleed at all edges in art files.

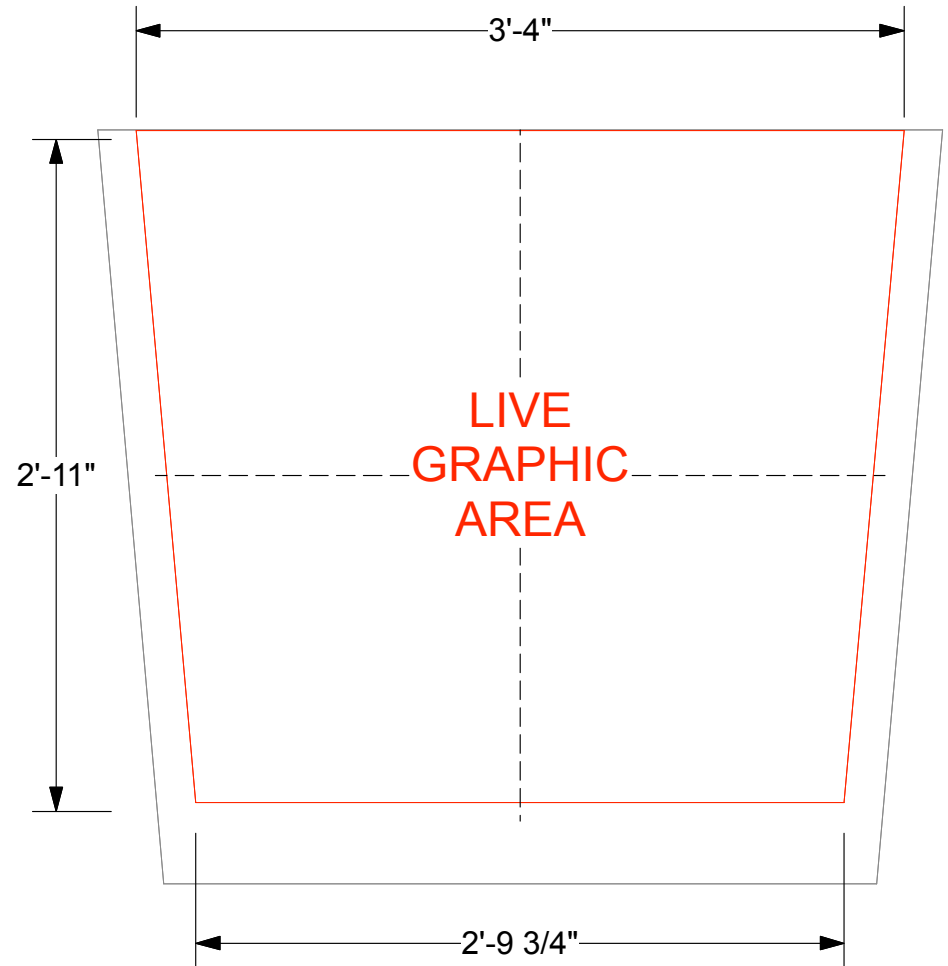

- COUNTER, 44"w x 39.25"h total dimension of front
- MAXIMUM LIVE GRAPHIC AREA, 40"w x 35"h



DRAWN BY: NG

DESIGN : EV2 Graphic Production Materials

DATE: 8/28/17

REFERENCE: EV2 - STNDLN © Trussworks 2017

The designs shown herein are the proprietary property of Trussworks and protected by copyright and other laws. This document is to be maintained in confidence. No portion of the information or design shown herein may be reproduced, electronically or otherwise, nor may any display be made from this design without written consent from Trussworks.